

## HSS - SINGLE ACTING MULTI-PURPOSE CYLINDERS

B



Capacities from 4.5 to 109 tonnes

Stroke lengths from 25 to 457mm

Working pressure 700 Bar

The HSS single acting multi-purpose cylinder range offers the widest choice of stroke lengths and lifting capacities available, and provides an excellent choice for maintenance, production, fabrication and construction applications. All models are provided with a collar thread and thread protector, cylinder base and piston rod mountings for easy fixturing, making the HSS range the most versatile and adaptable multi-purpose cylinders available. Major user industries include power generation, railways, steelworks, mining, shipyards and oil & gas.

- >> Spring assisted return
- >> Nitrocarburised piston rod
- >> Low friction bearing surfaces
- >> Anti-extrusion seals
- >> Collar threads withstand full load
- >> Piston rod thread on all models up to 30t
- >> Base mounting holes on all models (except HSS308)
- >> Optional piston rod saddles (see pages 26 - 27)
- >> Collar thread protector supplied as standard

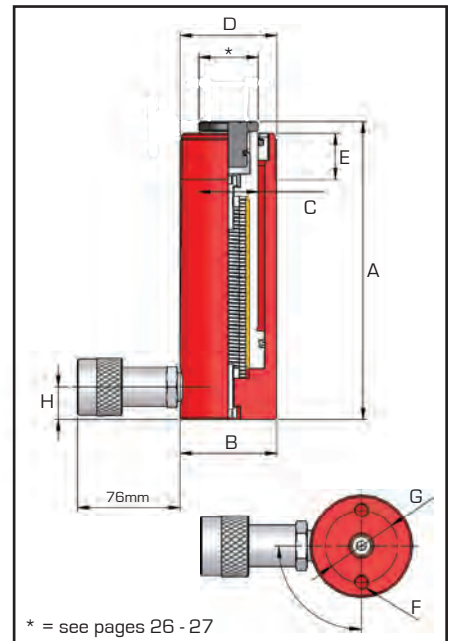

Lightweight aluminium alternatives available (see page 16)

Model number	Capacity tonnes	Stroke mm	Oil cap. cm <sup>3</sup>	Cyl. eff. area cm <sup>2</sup>	Weight kg
HSS51	4.5	25	16	6.4	1.0
HSS52	4.5	50	32	6.4	1.2
HSS53	4.5	75	48	6.4	1.4
HSS54	4.5	100	64	6.4	1.5
HSS55	4.5	125	80	6.4	1.8
HSS57	4.5	176	113	6.4	2.0
HSS59	4.5	227	146	6.4	2.4
HSS101	10	25	36	14.4	1.8
HSS102	10	56	81	14.4	2.4
HSS104	10	100	144	14.4	3.0
HSS106	10	150	217	14.4	4.2
HSS108	10	206	297	14.4	5.0
HSS1010	10	250	361	14.4	5.4
HSS1012	10	305	440	14.4	6.2

Dimensions in mm (unless otherwise stated)							
A	B	C	D	E	F	G	H
107	38	24	1 1/2"-16un	28	M6	25	19
132	38	24	1 1/2"-16un	28	M6	25	19
157	38	24	1 1/2"-16un	28	M6	25	19
182	38	24	1 1/2"-16un	28	M6	25	19
207	38	24	1 1/2"-16un	28	M6	25	19
258	38	24	1 1/2"-16un	28	M6	25	19
308	38	24	1 1/2"-16un	28	M6	25	19
100	57	35	2 1/4"-14un	27	M8	40	19
131	57	35	2 1/4"-14un	27	M8	40	19
175	57	35	2 1/4"-14un	27	M8	40	19
225	57	35	2 1/4"-14un	27	M8	40	19
281	57	35	2 1/4"-14un	27	M8	40	19
325	57	35	2 1/4"-14un	27	M8	40	19
379	57	35	2 1/4"-14un	27	M8	40	16

## HSS - SINGLE ACTING MULTI-PURPOSE CYLINDERS



Spring assisted return

Nitrocarburised piston rod

Working pressure 700 Bar

B

- >> Capacities from 4.5 to 109 tonnes
- >> Stroke lengths from 25 to 457mm
- >> Low friction bearing surfaces
- >> Anti-extrusion seals
- >> Collar threads withstand full load
- >> Piston rod thread on all models up to 30t
- >> Base mounting holes on all models (except HSS308)
- >> Optional piston rod saddles (see pages 26 - 27)
- >> Collar thread protector supplied as standard

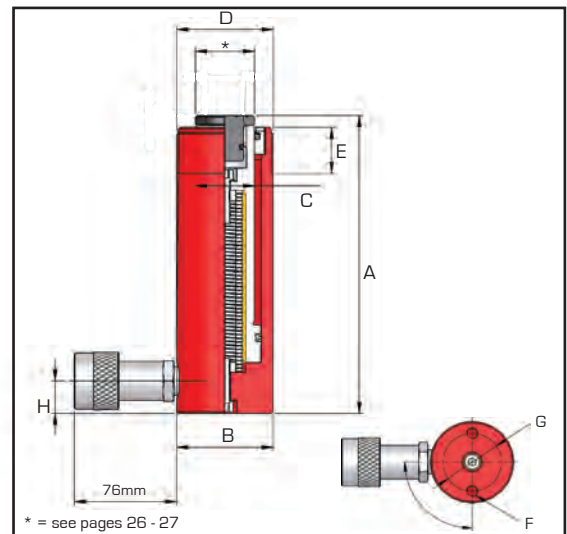

Model number	Capacity tonnes	Stroke mm	Oil cap. cm <sup>3</sup>	Cyl. eff. area cm <sup>2</sup>	Weight kg
HSS152	14.5	50	101	20.3	3.4
HSS154	14.5	100	203	20.3	5.0
HSS156	14.5	150	304	20.3	6.6
HSS1510	14.5	250	507	20.3	8.8
HSS252	25	51	178	34.9	6.5
HSS254	25	102	356	34.9	8.0
HSS256	25	150	524	34.9	9.6
HSS258	25	203	709	34.9	11.2
HSS2510	25	250	874	34.9	12.6
HSS2514	25	356	1242	34.9	16.8
HSS2518	25	457	1597	34.9	21.4
HSS308	29	205	860	41.9	18.6
HSS502	50	51	364	71.3	13.0
HSS504	50	102	728	71.3	16.8
HSS506	50	152	1084	71.3	20.0
HSS508	50	203	1448	71.3	23.2
HSS5013	50	330	2354	71.3	33.6
HSS756	73	152	1561	102.7	31.0
HSS1004	109	102	1565	153.4	41.6
HSS1006	109	153	2347	153.4	49.8
HSS10010	109	254	3896	153.4	65.5

Dimensions in mm (unless otherwise stated)							
A	B	C	D	E	F	G	H
154	70	41	2 3/4"-16un	39	M10	48	19.0
204	70	41	2 3/4"-16un	39	M10	48	19.0
254	70	41	2 3/4"-16un	39	M10	48	19.0
354	70	41	2 3/4"-16un	39	M10	48	19.0
174	86	54	3 5/16"-12un	49	M12	60	25.0
225	86	54	3 5/16"-12un	49	M12	60	25.0
273	86	54	3 5/16"-12un	49	M12	60	25.0
324	86	54	3 5/16"-12un	49	M12	60	25.0
374	86	54	3 5/16"-12un	49	M12	60	25.0
480	86	54	3 5/16"-12un	49	M12	60	25.0
611	86	54	3 5/16"-12un	49	M12	60	25.0
374	102	57	3 5/16"-12un	50	-	-	50.0
150	127	79	5"-12un	55	M12	85	20.0
201	127	79	5"-12un	55	M12	85	20.0
251	127	79	5"-12un	55	M12	85	20.0
302	127	79	5"-12un	55	M12	85	20.0
429	127	79	5"-12un	55	M12	85	20.0
272	146	95	5 3/4"-12un	45	M12	115	31.5
223	185	114	6 7/8"-12un	50	M12	146	32.0
274	185	114	6 7/8"-12un	50	M12	146	32.0
375	185	114	6 7/8"-12un	50	M12	146	32.0