

BC | BATTERY OPERATED CABLE CRIMPING TOOLS



Fast self-contained battery powered tools

Supplied complete with standard set of dies

Lightweight and easy to operate

- ▶ Open jaw design with rotating head (excl. BC18X & BC63)
- ▶ Fast and quiet operation with no vibration
- ▶ Built in automatic pump pressure release valve
- ▶ Low battery power warning light
- ▶ Supplied complete with battery, charger, carrying strap and storage case

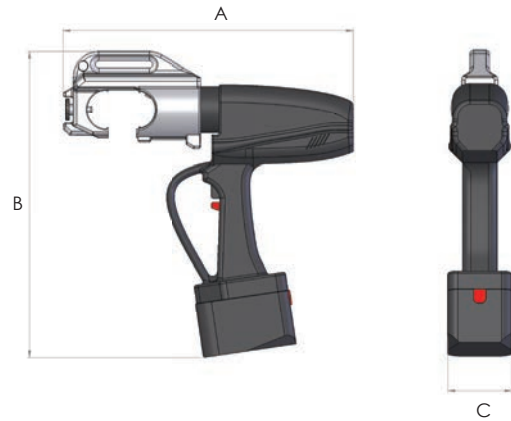

Model number	Output (tonnes)	C-Jaw opening	Applicable range DIN (mm ²)	Standard dies (mm ²)	Weight (kg)	Dimensions (mm)		
						A	B	C
BC18X	5	not applicable	10 - 185	With die 10-16, 25-35, 50-70, 95-120, 150, 185	3.8	370	280	70
BC30	10	30 mm	35 - 400	With die 35, 50, 70, 95, 120, 150, 185, 240, 300, 400	5.9	400	280	70
BC40	10	38 mm	35 - 400	With die 35, 50, 70, 95, 120, 150, 185, 240, 300, 400	7.2	430	270	70
BC63	16	not applicable	35 - 630	With die 35, 50, 70, 95, 120, 150, 185, 240, 300, 400, 500, 630	6.9	420	320	75

OPTIONAL DIE SETS

Model number	Description
CD10	Die set 10 mm ² , suitable for crimping tool BC30, BC40 & BC63
CD16	Die set 16 mm ² , suitable for crimping tool BC30, BC40 & BC63
CD25	Die set 25 mm ² , suitable for crimping tool BC30, BC40 & BC63