

HHP | HOLE PUNCHERS



Punching force up to 50 tonnes

Throat depth up to 75 mm

Working pressure 700 bar

- ▶ Choice of single or double acting models
- ▶ Fitted with integral positioning and carrying handle
- ▶ Supplied with standard set of punches and dies
- ▶ Includes standard quick connect couplings for easy attachment to pump and hose

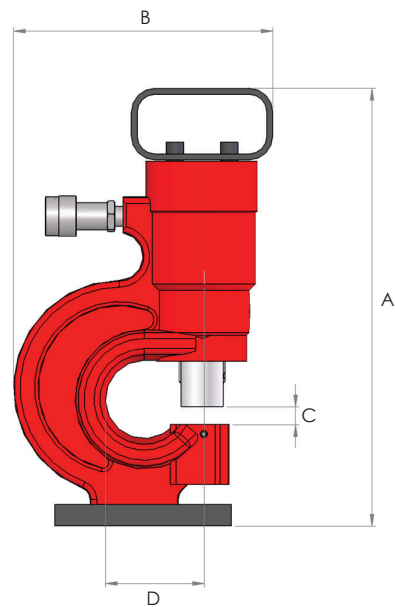

Model number	Maximum force (tonnes)	Throat depth (mm)	Punch capacity (mm)		Standard punch/die sets included (mm)	Weight excluding pump (kg)	Dimensions (mm)			
			Steel plate	Hole punch diameter			A	B	C	D
HHP30	30	75	10	up to 20.5	10.5, 13.5 17.5, 20.5	13	375	220	15	75
HHP50	50	65	15	up to 25.5	10.5, 13.5 17.5, 20.5, 25.5	42	425	281	15	65

Model number	Recommended pump and hose	
	Manually operated	Pneumatically operated
HHP30	HP232 complete with HC3 3m hose	AHP1120 complete with HC3 3m hose
HHP50	HP232D complete with 2 x HC3 3m hose	AHP1141 complete with 2 x HC3 3m hose

Note: Pumps and hoses supplied separately