

IMPORTANT
WHEN ORDERING SPARES YOU MUST STATE THE FULL PART NUMBER AND THE
PRODUCT SERIAL NUMBER - FROM THE LABEL
TO PROTECT YOUR WARRANTY ALWAYS USE GENUINE HI-FORCE PARTS.

ITEM NO.	HPF10020	HPF10030	HPF10041	HPF10042	HPF10044
1	PAA100HM001	PAA100HM001	PAA100HM001	PAA100HM001	PAA100HM001
2	HP235D	HAP21042	HEP207421	HEP207422	HEP207424
3	PLC100EU001	PLC100EU001	PLC100EU001	PLC100EU001	PLC100EU001
4	STC040RA001	STC040RA001	STC040RA001	STC040RA001	STC040RA001
5	HPG-100T	HPG-100T	HPG-100T	HPG-100T	HPG-100T
6	HH2	HH2	HH2	HH2	HH2
7	CM1	CM1	CM1	CM1	CM1
8	HF31	HF31	HF31	HF31	HF31
9	CF1	CF1	CF1	CF1	CF1
10	FPC010YN001	FPC010YN001	FPC010YN001	FPC010YN001	FPC010YN001
11	CF1	CF1	CF1	CF1	CF1
12	HF16	HF16	HF16	HF16	HF16
13	HF16	HF16	HF16	HF16	HF16
14	FPC006YN001	FPC006YN001	FPC006YN001	FPC006YN001	FPC006YN001

IMPORTANT

WHEN ORDERING SPARES YOU MUST STATE THE FULL PART NUMBER AND THE
PRODUCT SERIAL NUMBER - FROM THE LABEL
TO PROTECT YOUR WARRANTY ALWAYS USE GENUINE HI-FORCE PARTS.

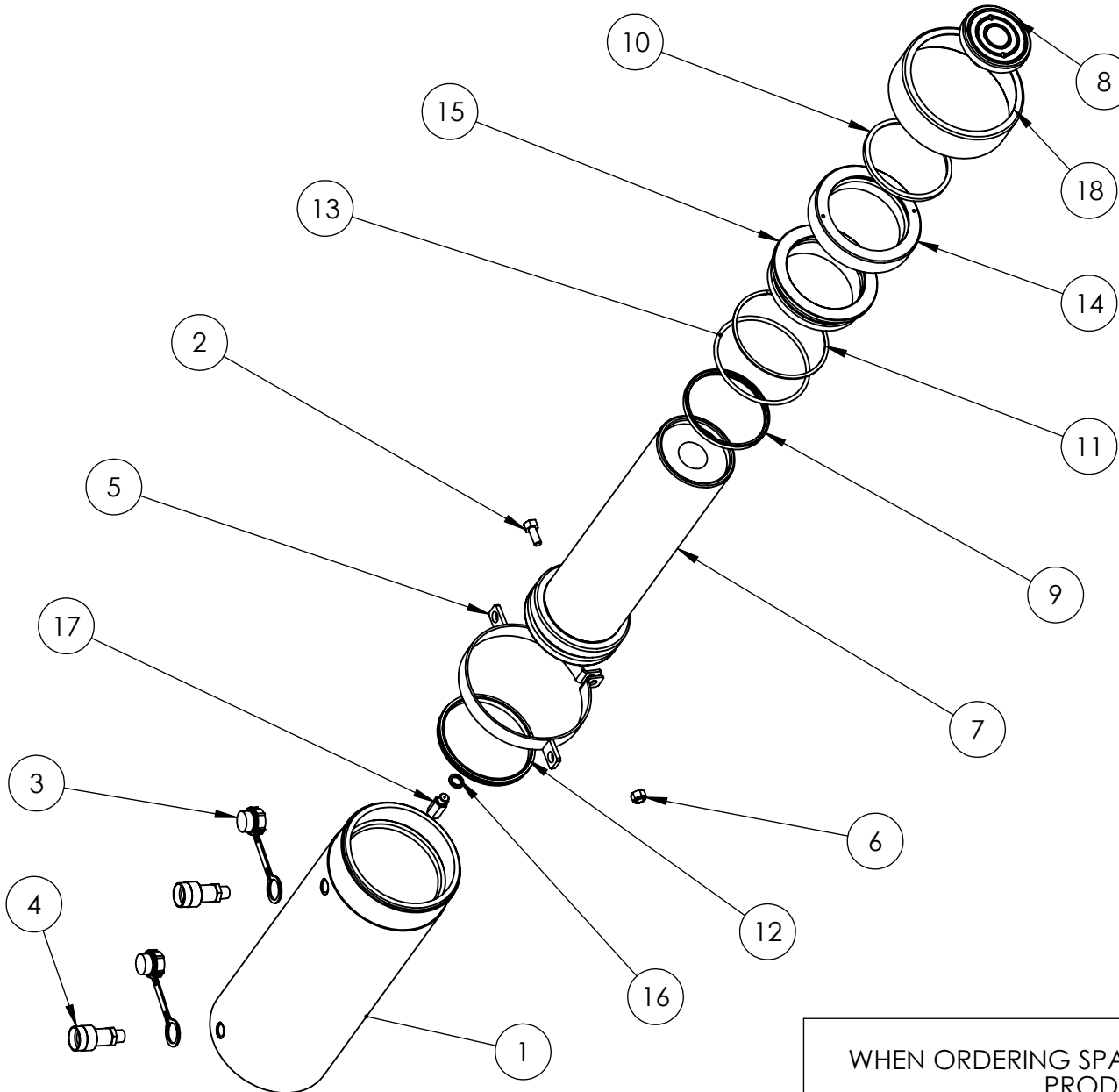

ITEM NO.	PART NUMBER	DESCRIPTION	QTY.
1	CBC140AN003	CYLINDER	1
2	BLC010LB025	BOLT	1
3	BPC030PP001	DUST COVER	2
4	CF1	COUPLER	2
5	FLC178LA002	LIFTING RING	1
6	NUC010LC000	NUT	1
7	PRC140VN002	PISTON	1
8	SAC045MT001	SADDLE	1
9	X	ROD SEAL	1
10	X	WIPER	1
11	X	BACK UP RING	1
12	X	PISTON SEAL	1
13	X	O - RING	1
14	SRC114WN001	STOP RING	1
15	SSC140EA001	SEAL RETAINER	1
16	X	DOWTY WASHER	1
17	VRA700AF002	RELIEF VALVE	1
18	PTP175TP100	THREAD PROTECTOR	1

ALL ITEMS MARKED 'X' SUPPLIED IN KIT HDA100TP1-K ONLY.

IMPORTANT
WHEN ORDERING SPARES YOU MUST STATE THE FULL PART NUMBER AND THE
PRODUCT SERIAL NUMBER - FROM THE LABEL
TO PROTECT YOUR WARRANTY ALWAYS USE GENUINE HI-FORCE PARTS.

ROLL FRAME,
(IF FITTED)

MOTOR

VALVE

VALVE VARIATIONS

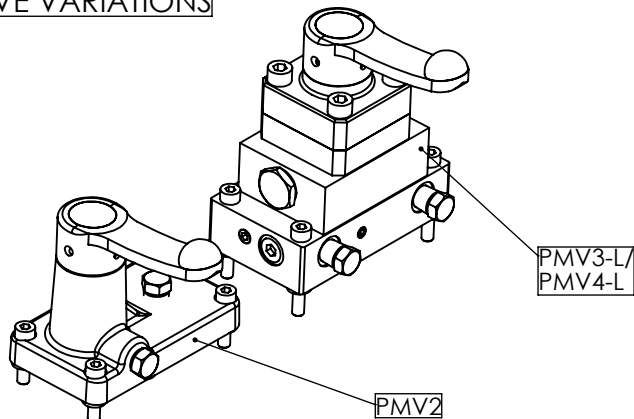

FILLER/ BREATHER
PT NO: FFC028PZ001

CONNECTOR

FEED PIPE

GASKET.
PT NO: SEC165KF001

GASKET.
PT NO: 15482

PUMP

GEAR PUMP

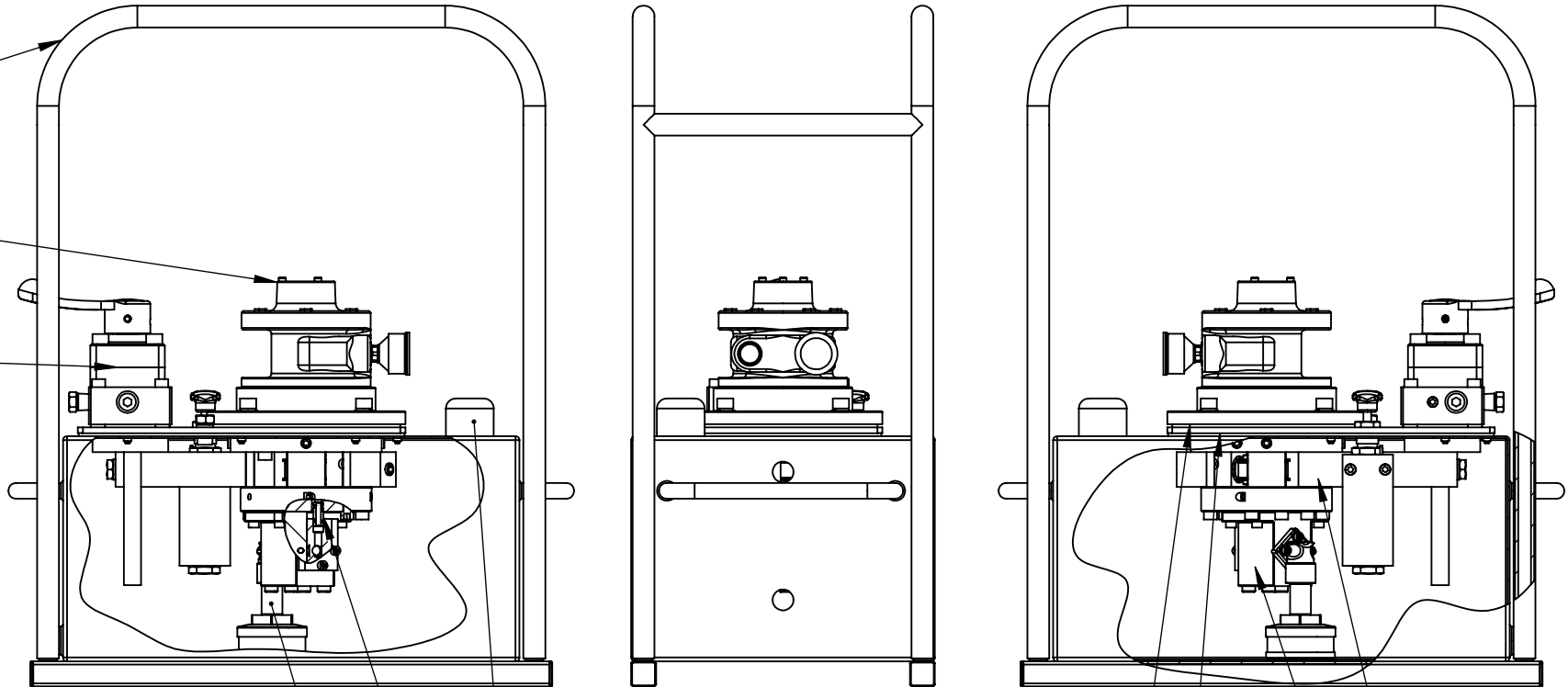

IMPORTANT

WHEN ORDERING SPARES YOU MUST STATE THE FULL PART NUMBER AND THE PRODUCT SERIAL NUMBER - FROM THE LABEL TO PROTECT YOUR WARRANTY ALWAYS USE GENUINE HI-FORCE PARTS.

MODEL				PUMP	VALVE	TANK	MOTOR	GEAR PUMP	CONNECTOR	FEED PIPE
HAP21	0	1	1	TYPE200-19	PM1	PPR10	AM1	GP36	15510B	FPC013NC001, FPC013FC001
HAP21	0	1	2	TYPE200-19	PM1	PPR25	AM1	GP36	15510B	FPC013AC001
HAP21	0	1	4	TYPE200-19	PM1	PPR40	AM1	GP36	15510B	FPC013AC002
HAP21	0	1	6	TYPE200-19	PM1	PPR60	AM1	GP36	15510B	FPC013AC002
HAP21	0	2	1	TYPE200-19	PMV2	PPR10	AM1	GP36	15510B	FPC013NC001, FPC013FC001
HAP21	0	2	2	TYPE200-19	PMV2	PPR25	AM1	GP36	15510B	FPC013AC001
HAP21	0	2	4	TYPE200-19	PMV2	PPR40	AM1	GP36	15510B	FPC013AC002
HAP21	0	2	6	TYPE200-19	PMV2	PPR60	AM1	GP36	15510B	FPC013AC002
HAP21	0	3	1	TYPE200-19	PMV3-L	PPR10	AM1	GP36	15510B	FPC013NC001, FPC013FC001
HAP21	0	3	2	TYPE200-19	PMV3-L	PPR25	AM1	GP36	15510B	FPC013AC001
HAP21	0	3	4	TYPE200-19	PMV3-L	PPR40	AM1	GP36	15510B	FPC013AC002
HAP21	0	3	6	TYPE200-19	PMV3-L	PPR60	AM1	GP36	15510B	FPC013AC002
HAP21	0	4	1	TYPE200-19	PMV4-L	PPR10	AM1	GP36	15510B	FPC013NC001, FPC013FC001
HAP21	0	4	2	TYPE200-19	PMV4-L	PPR25	AM1	GP36	15510B	FPC013AC001
HAP21	0	4	4	TYPE200-19	PMV4-L	PPR40	AM1	GP36	15510B	FPC013AC002
HAP21	0	4	6	TYPE200-19	PMV4-L	PPR60	AM1	GP36	15510B	FPC013AC002

IMPORTANT

WHEN ORDERING SPARES YOU MUST STATE THE FULL PART NUMBER AND THE PRODUCT SERIAL NUMBER - FROM THE LABEL TO PROTECT YOUR WARRANTY ALWAYS USE GENUINE HI-FORCE PARTS.

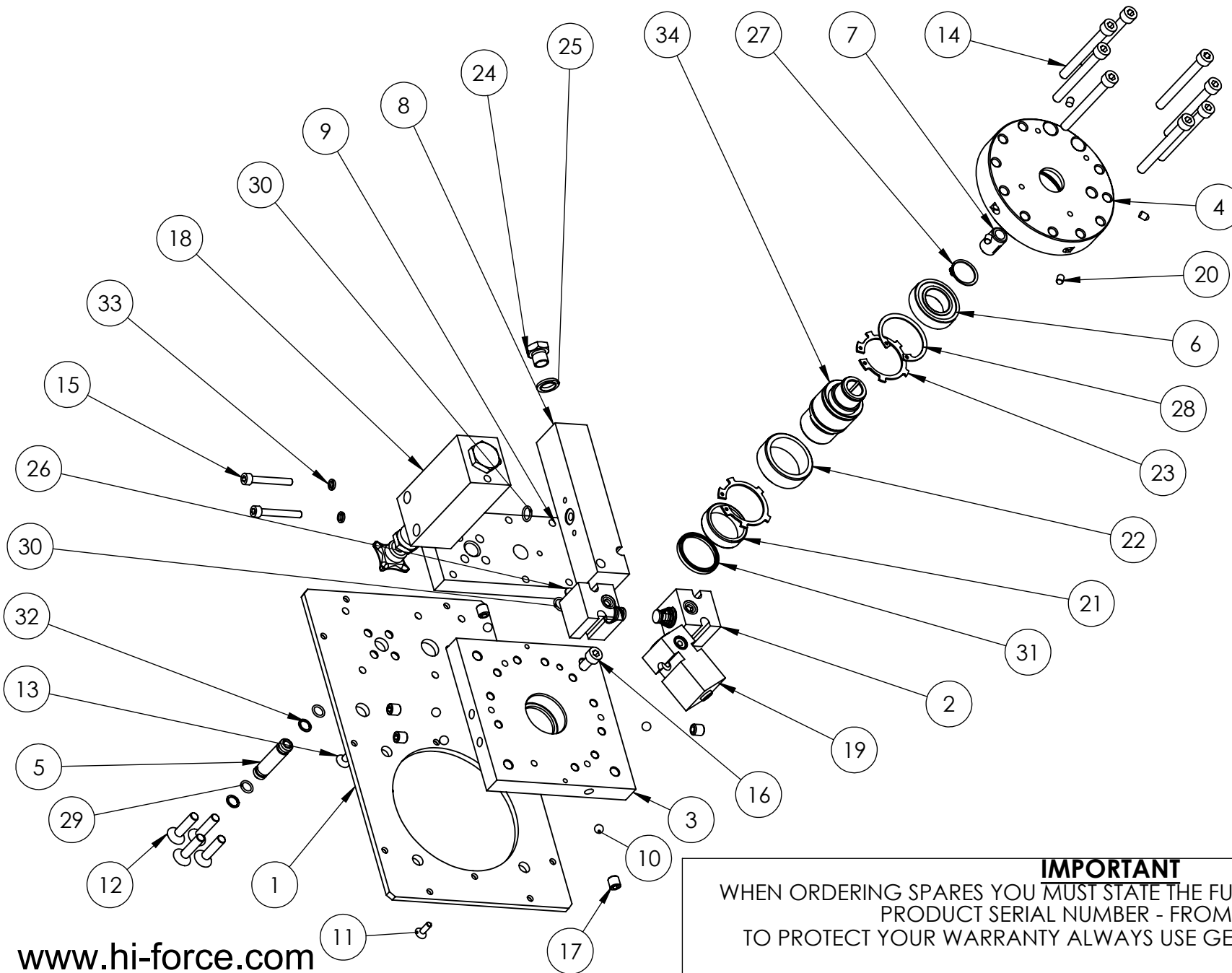

SHEET 1 OF 2.

IMPORTANT
WHEN ORDERING SPARES YOU MUST STATE THE FULL PART NUMBER AND THE
PRODUCT SERIAL NUMBER - FROM THE LABEL
TO PROTECT YOUR WARRANTY ALWAYS USE GENUINE HI-FORCE PARTS.

ITEM NO.	PART NUMBER	DESCRIPTION	QTY.
1	TAC000BA003	COVER PLATE	1
2	15494A	PISTON BLOCK ASSY.	2
3	15497	UPPER PLATE	1
4	15499	LOWER PLATE	1
5	E15503	CONNECTOR PIPE	1
6	BSC025MC001	LOWER PLATE BEARING	1
7	15507	ADAPTOR	1
8	17587	TRANSFER BLOCK	1
9	17588	VALVE PLATE	1
10	BAC008SN000	8mm BALL	5
11	BLC005HF016	SKT CSK SCREW	2
12	BLC008KF035	SKT CSK SCREW	4
13	BLC006JE016	SKT CSK SCREW	1
14	BLC008KC080	CAP HD SCREW	8
15	BLC006JC045	CAP HD SCREW	2
16	BLC008KD016	CAP HD SCREW	1
17	FAS010MA010	M10 X 10 CUP POINT GRUB SCREW	5
18	HPRV1	HIGH PRESSURE R/VALVE	1
19	LPRV1	LOW PRESSURE R/VALVE	1
20	BPC006RS001	SEALING PLUG	4
21	BSC035NC001	UPPER PLATE BEARING	1
22	BSC040ND001	ECCENTRIC BEARING	1
23	STC040AA001	CIRCLIP TYPE 200/300	2
24	FAS006GJ010	1/4 INCH BLANKING PLUG	1
25	X	DOWTY WASHER	1
26	FFC012MA001	SUCTION FILTER	1
27	STC025AA001	CIRCLIP	1
28	STC047BA001	CIRCLIP	1
29	X	O - RING	2
30	X	O - RING	2
31	X	UPPER PLATE OIL SEAL	1
32	X	BACK UP RING	2
33	WAC006BC001	SPRING WASHER	2
34	15498	19MM DRIVE SHAFT	1

NOTE: PARTS MARKED 'X' SUPPLIED IN KIT HEP207TP1-K ONLY.

SHEET 2 OF 2.

IMPORTANT

WHEN ORDERING SPARES YOU MUST STATE THE FULL PART NUMBER AND THE PRODUCT SERIAL NUMBER - FROM THE LABEL TO PROTECT YOUR WARRANTY ALWAYS USE GENUINE HI-FORCE PARTS.

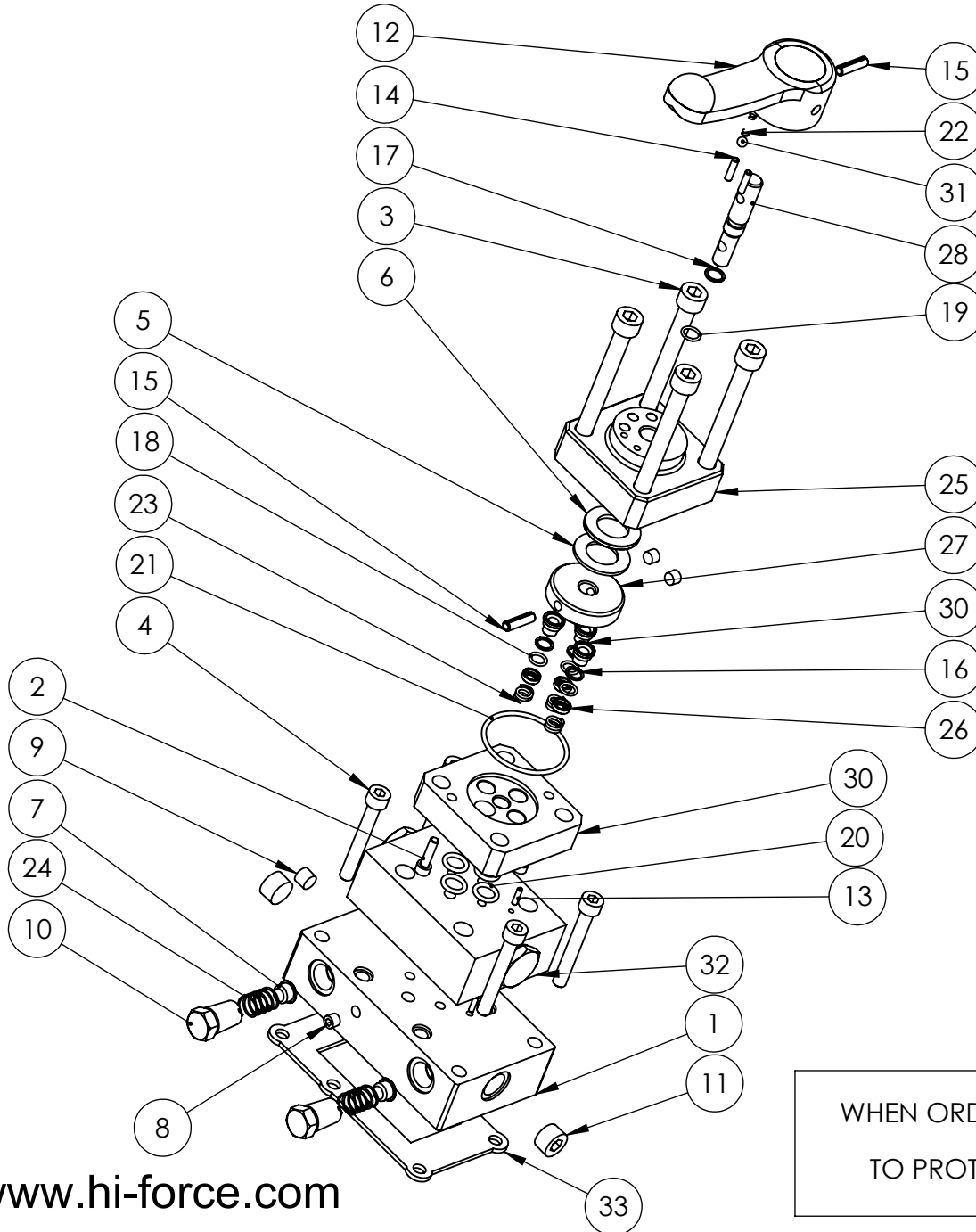

ITEM NO.	PART NUMBER	DESCRIPTION	QTY.
1	VFC010BF007	VALVE MOUNTING BLOCK	1
2	BLC005HU020	CAP HD SCREW	2
3	BLC010LC100	CAP HD SCREW	4
4	BLC008KC060	CAP HD SCREW	4
5	BSC035NA001	NEEDLE BEARING	1
6	BSC035NA002	HOUSING WASHER	1
7	FFC011MG001	LAST CHANCE FILTER	2
8	FPC002PN001	PLUG	3
9	FPC003PN001	PLUG	1
10	FPC010PN001	3/8 NPT BLANKING PLUG	2
11	FPC010PN002	3/8 X 7/8 IN. NPT SOCKET PLUG	2
12	HLC012LP002	HANDLE	1
13	PCC003RB006	SPRING PIN	2
14	PCC004RC001	SPRING PIN	2
15	PCC006RD000	SPRING PIN	2
16	X	BACK UP RING	3
17	X	BACK UP RING	1
18	X	O - RING	3
19	X	O - RING	1
20	X	O - RING	4
21	X	O - RING	1
22	SPC005CA001	SPRING	1
23	SPC010CA001	SPRING	3
24	SPC014LC001	COMPRESSION SPRING FOR FILTER	2
25	VFC000BD003	VALVE BODY	1
26	VFC000SC001	SHEAR SEAL COLLAR	3
27	VFC000SQ002	VALVE ROTOR	1
28	VFC000SR002	SPINDLE	1
30	VFC000ST001	SHEAR SEAL PLATE	1
30	VFC000SU001	SHEAR SEAL	3
31	X	6 mm BALL	1
32	V-8245	DUAL CHECK VALVE	1
33	X	GASKET	1

ALL PARTS MARKED 'X' SUPPLIED IN KIT PMV4TP1-K ONLY.

IMPORTANT

WHEN ORDERING SPARES YOU MUST STATE THE FULL PART NUMBER AND THE PRODUCT SERIAL NUMBER - FROM THE LABEL TO PROTECT YOUR WARRANTY ALWAYS USE GENUINE HI-FORCE PARTS.

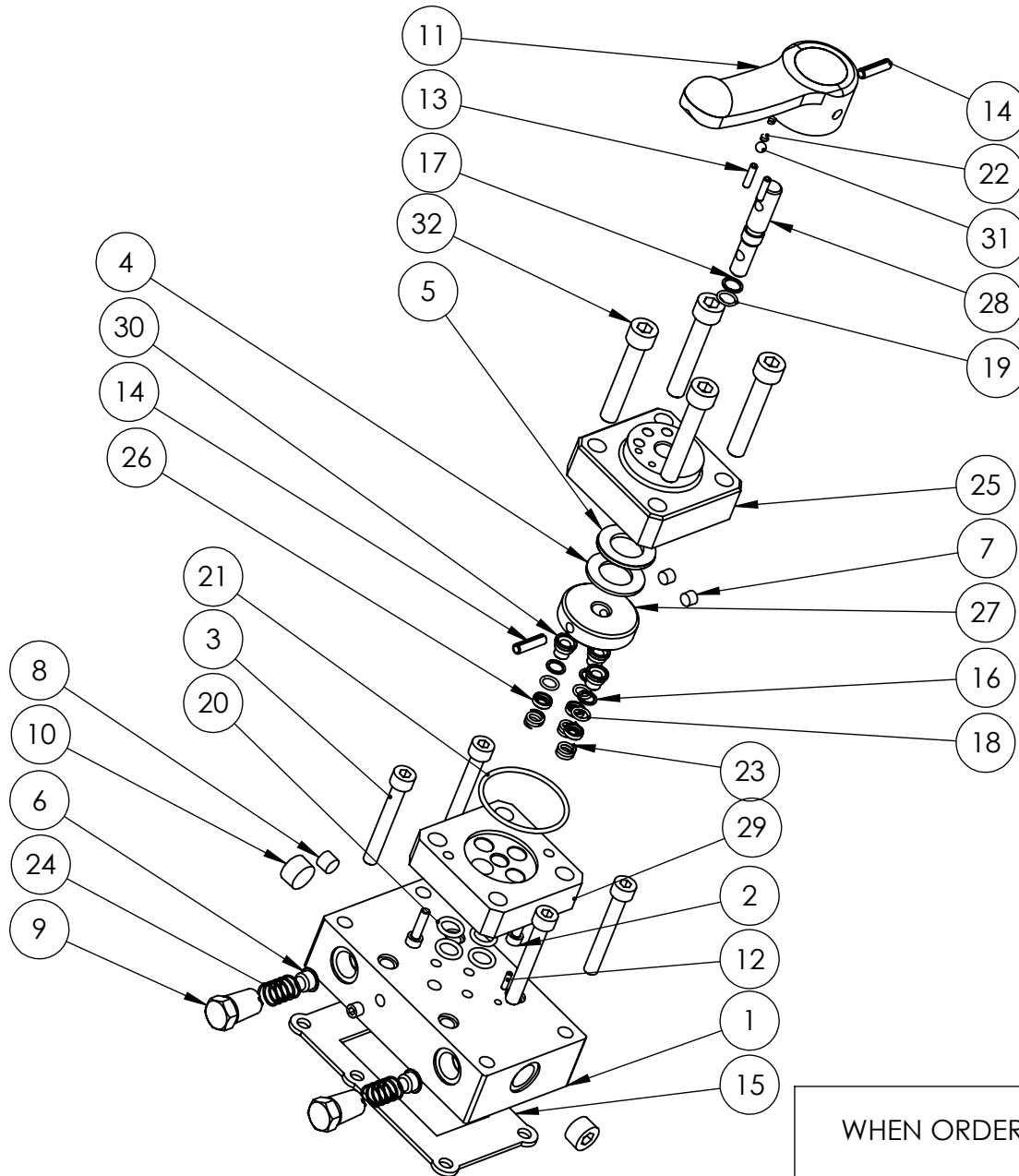

ITEM NO.	PART NUMBER	DESCRIPTION	QTY.
1	VFC010BF007	VALVE MOUNTING BLOCK	1
2	BLC005HU020	CAP HD SCREW	2
3	BLC008KC060	CAP HD SCREW	4
4	BSC035NA001	NEEDLE BEARING	1
5	BSC035NA002	HOUSING WASHER	1
6	FFC011MG001	LAST CHANCE FILTER	2
7	FPC002PN001	PLUG	3
8	FPC003PN001	PLUG	1
9	FPC010PN001	3/8 NPT BLANKING PLUG	2
10	FPC010PN002	3/8 X 7/8 IN. NPT SOCKET PLUG	2
11	HLC012LP002	HANDLE	1
12	PCC003RB006	SPRING PIN	1
13	PCC004RC001	SPRING PIN	2
14	PCC006RD000	SPRING PIN	2
15	X	GASKET	1
16	X	BACK UP RING	3
17	X	BACK UP RING	1
18	X	O - RING	3
19	X	O - RING	1
20	X	O - RING	4
21	X	O - RING	1
22	SPC005CA001	SPRING	1
23	SPC010CA001	SPRING	3
24	SPC014LC001	COMPRESSION SPRING FOR FILTER	2
25	VFC000BD003	VALVE BODY	1
26	VFC000SC001	SHEAR SEAL COLLAR	3
27	VFC000SQ002	VALVE ROTOR	1
28	VFC000SR002	SPINDLE	1
29	VFC000ST001	SHEAR SEAL PLATE	1
30	VFC000SU001	SHEAR SEAL	3
31	X	6 mm BALL	1
32	BLC010LC060	CAP HD SCREW	4

ALL PARTS MARKED 'X' SUPPLIED IN KIT PMV4TP1-K ONLY

IMPORTANT

WHEN ORDERING SPARES YOU MUST STATE THE FULL PART NUMBER AND THE PRODUCT SERIAL NUMBER - FROM THE LABEL TO PROTECT YOUR WARRANTY ALWAYS USE GENUINE HI-FORCE PARTS.

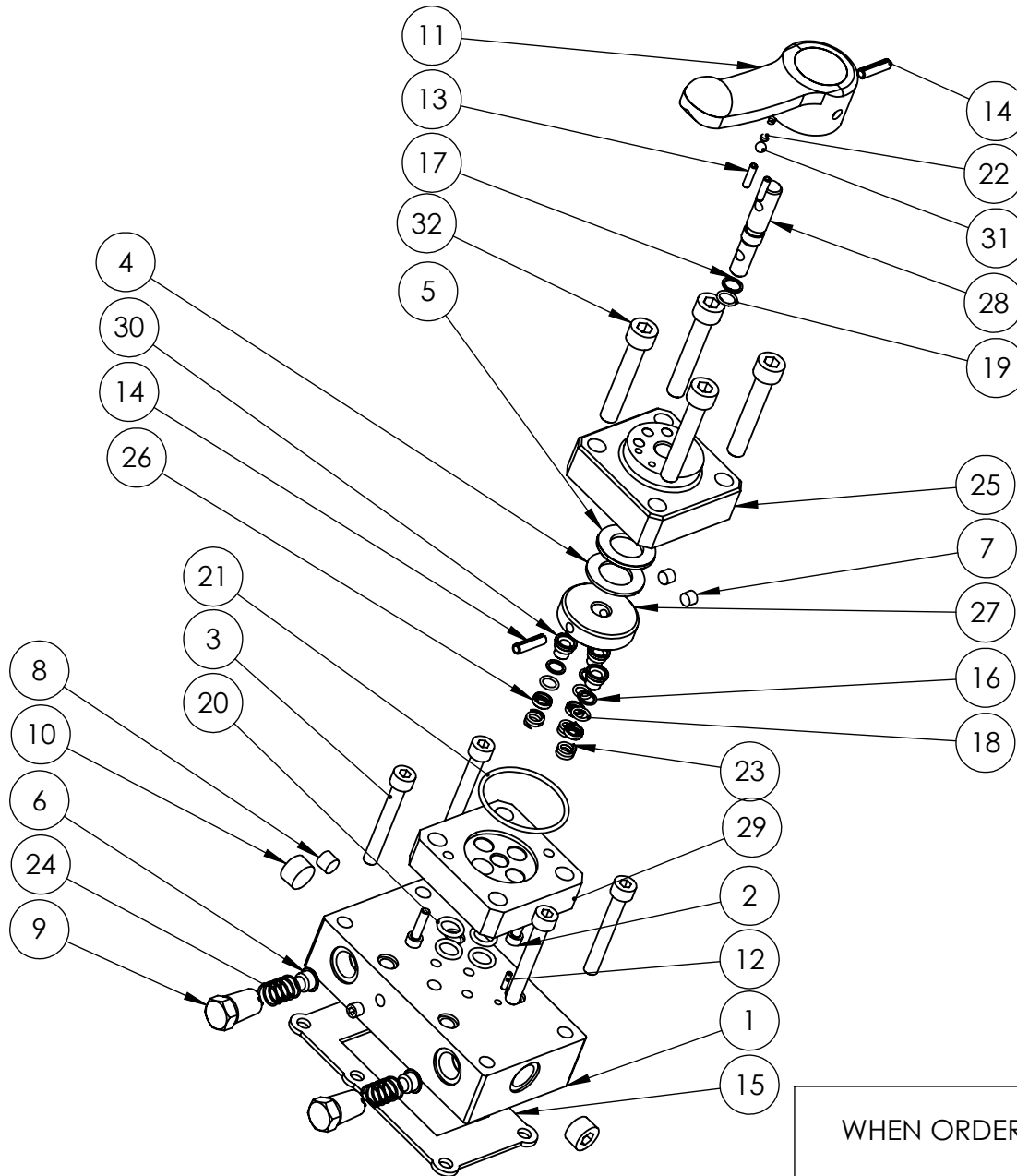

ITEM NO.	PART NUMBER	DESCRIPTION	QTY.
1	VFC010BF007	VALVE MOUNTING BLOCK	1
2	BLC005HU020	CAP HD SCREW	2
3	BLC008KC060	CAP HD SCREW	4
4	BSC035NA001	NEEDLE BEARING	1
5	BSC035NA002	HOUSING WASHER	1
6	FFC011MG001	LAST CHANCE FILTER	2
7	FPC002PN001	PLUG	3
8	FPC003PN001	PLUG	1
9	FPC010PN001	3/8 NPT BLANKING PLUG	2
10	FPC010PN002	3/8 X 7/8 IN. NPT SOCKET PLUG	2
11	HLC012LP002	HANDLE	1
12	PCC003RB006	SPRING PIN	1
13	PCC004RC001	SPRING PIN	2
14	PCC006RD000	SPRING PIN	2
15	X	GASKET	1
16	X	BACK UP RING	3
17	X	BACK UP RING	1
18	X	O - RING	3
19	X	O - RING	1
20	X	O - RING	4
21	X	O - RING	1
22	SPC005CA001	SPRING	1
23	SPC010CA001	SPRING	3
24	SPC014LC001	COMPRESSION SPRING FOR FILTER	2
25	VFC000BD003	VALVE BODY	1
26	VFC000SC001	SHEAR SEAL COLLAR	3
27	VFC000SQ002	VALVE ROTOR	1
28	VFC000SR002	SPINDLE	1
29	VFC000ST001	SHEAR SEAL PLATE	1
30	VFC000SU001	SHEAR SEAL	3
31	X	6 mm BALL	1
32	BLC010LC060	CAP HD SCREW	4

ALL PARTS MARKED 'X' SUPPLIED IN KIT PMV4TP1-K ONLY

IMPORTANT

WHEN ORDERING SPARES YOU MUST STATE THE FULL PART NUMBER AND THE PRODUCT SERIAL NUMBER - FROM THE LABEL TO PROTECT YOUR WARRANTY ALWAYS USE GENUINE HI-FORCE PARTS.