

Hi-Force®
HYDRAULIC TOOLS
INSTRUCTION MANUAL: Aluminium Jacks
Model Series: JAS, JAH

All Hi-Force JAS and JAH series jacks are supplied from the factory pre-filled with oil, and are ready for use.

1.0 Inspection of the product upon receipt:

On receipt of the product, visually inspect the item for any evidence of shipping damage. Please note shipping damage is not covered by warranty. If shipping damage is found notify the carrier immediately and refrain from putting the product into service. The carrier is responsible for repair and replacement costs resulting from damage in transit shipment.

2.0 Safety Precautions:



Read and follow all the instructions and safety warnings carefully prior to use of the equipment. Failure to do so could result in equipment damage or failure of the equipment or personal injury. Hi-Force will not be held responsible for any damage to the equipment or personal injury resulting from unsafe use of the product, lack of maintenance or incorrect operation. If in doubt on the correct usage of any Hi-Force equipment, contact your nearest Hi-Force office or distributor. If the operator has not been trained on high pressure hydraulic equipment and its safe use consult your local Hi-Force sales office who can offer you training courses for operators.



All operators should ensure that all necessary personal protective equipment as specified by their employer is worn when operating any hydraulic equipment. Safety shoes, safety glasses/ visor and protective gloves should be worn at all times. All relevant risk assessments should be completed prior to use of the equipment.

Description:

This equipment is provided for the purpose of lifting or lowering loads, or exerting a force, under the control of a trained operator.

The equipment is supplied completely assembled and ready for use. No service adjustments are necessary or possible during operation.

An internal safety relief valve (factory set) is fitted which limits the load that may be lifted to the equipment rated load + 10% maximum.

 Keep hydraulic Jacks away from flames and direct heat.

Hydraulic Jacks must only be serviced by a qualified technician.

To protect your warranty, only use Hi-Force's hydraulic oil.

Immediately replace any worn or damaged parts using genuine Hi-Force parts only.

Model Series: JAS103, JAS105



Hi-Force JAS Jacks are despatched from the factory pre-filled with oil, and are ready for use. They can be used, if installed correctly, in any position, for example sideways, upside down etc.

Hi-Force JAS Jacks are supplied in two model options:-

JAS103 10tonne Capacity 75mm stroke.

JAS105 10tonne Capacity 125mm stroke.

There are two safety devices fitted as follows:

- Pressure Relief Valve to prevent overloading.
- Steel stop ring to limit maximum stroke.

3.0 Operation.

TO LIFT OR PUSH LOAD

Using the Operating Lever Assembly turn Release Valve Screw clockwise to close.

Put the Operating Lever into the Handle Socket and operate pump. The piston will rise and lift the load. When the piston reaches full stroke the stop ring prevents the piston from rising further.

TO LOWER LOAD

Using the Operating Lever turn the Release Valve Screw anti-clockwise to open. Opening the Release Valve SLOWLY will control rate of lowering. Do NOT overload Jack during lowering. The JAS jacks are fitted with a return spring, so the piston will retract even under no load.

Hi-Force®

HYDRAULIC TOOLS
INSTRUCTION MANUAL: Aluminium Jacks
Model Series: JAS, JAH

CARE AND STORAGE

Wipe the piston clean before lowering. When the Hydraulic Jack is not in use store upright with the piston retracted in a clean environment.

SAFETY WARNINGS!

- ALWAYS raise the piston to the load.
- DO NOT drop loads onto the Jack.
- ALWAYS support the base of the Jack when in use.
- NEVER go under load when only the Jack supports it.
- DO NOT attempt to lift a load greater than the capacity of the Jack.
- Provide solid and flat foundation for the jack to operate from.
- Make sure that there is sufficient spare lifting capacity and stroke when selecting Jack/s for any application.
- Check the Jack load rating before use.
- Avoid off-centre loading.

Before using any hydraulic equipment, read the operating instructions carefully and check that they are fully understood.

Model Series JAH – 20tonne to 60tonne Capacity.

JAH1230C



Hi-Force JAH range of lightweight Aluminium jacks offer a wide variety of capacities and lift height options. Available as either plain ram lifting jacks, with or without 'failsafe' mechanical lock ring, or optional low height claw lifting design. All models are constructed of lightweight Aluminium with all critical functioning parts from high quality steel.

This manual covers the following model variants of Jack:-

JAH620, JAH1220, JAH630, JAH1230, JAH660, JAH1260

- Jacks with plain piston only

JAH620C, JAH1220C, JAH630C, JAH1230C, JAH660C, JAH1260C

- Jacks with plain piston and lifting claw attachment

JAH620SR, JAH1220SR, JAH630SR, JAH1230SR, JAH660SR, JAH1260SR

- Jacks with Failsafe locking ring.



Please read the following instructions carefully before operating the product and keep them in a safe place for future reference.

It is the responsibility of the purchaser to ensure that operators are properly trained in the safe use of this equipment and have access to **Hi-Force Operating and Safety Instructions**.

No modification and/or additions may be made to this equipment without the written permission of the manufacturer.

It is expected that the product is used by competent technical personnel who have been properly trained to use hydraulic lifting equipment

Description:

This equipment is provided for the purpose of lifting or lowering loads, or exerting a force, under the control of a trained operator.

The equipment is supplied completely assembled and ready for use. No service adjustments are necessary or possible during operation.

An internal safety relief valve (factory set) is fitted which limits the load that may be lifted to the equipment rated load + 10% maximum.



Before Each Use

- Ensure that the jack is in good condition.
- Check the external surfaces for absence of mechanical damage and/or oil leaks. If either is present do not use the equipment and have it serviced.
- Ensure that the external surfaces are dirt free.
- Check the oil level



GENERAL OPERATING INSTRUCTIONS

- Place the jack on a firm level foundation fully supporting the jack base, and if

Hi-Force Limited – Prospect Way – Daventry – Northants NN11 8PL – United Kingdom

Tel: +44(0) 1327 301000: Fax: +44(0) 1327 706555: Website: www.hi-force.com

Hi-Force[®]
HYDRAULIC TOOLS
INSTRUCTION MANUAL: Aluminium Jacks
Model Series: JAS, JAH

necessary place suitable material between the load point and jack ram to avoid damaging the structure to be lifted.

- Use the jack by operating the lever in a steady controlled movement at a maximum of 30 strokes per minute.
- Remove the operating lever when not in use.
- The ram should only be extended hydraulically; it should never be pulled out by hand or used to carry the jack.

SAFETY.

**READ THIS MANUAL BEFORE OPERATING THE JACK.
FAILURE TO OBSERVE THE FOLLOWING WARNINGS
COULD RESULT IN SERIOUS BODILY INJURY.**

- **Do Not** position the jack by using the operating lever in the release valve. If the jack is to be placed some distance under the load, use the operating lever in the operating lever/quadrant socket to position the jack.
- **Do not** attempt to exceed the rated load on the head or toe of the jack.
- The maximum working load and the travel of the hydraulic jack is marked on the equipment,
- In operation, never drop loads onto the jack. Always raise the head/toe to the load.
- **Always** ensure the full base area of the jack is supported when in use.
- **Always** ensure that loads are applied centrally to the ram, or to the full extent of the claw.
- **DO NOT** allow any persons to work under the load, when it is only supported by hydraulic jacks.
- Always clean the ram and retract it after use.
- **Always** remove the jack operating handle when not in use.
- **Do not** use if there is evidence of oil leakage.
- **Never** extend the ram by any means other than pumping the jack.
- Inspect and clean the jack after every use, but if subjected to abnormal or shock loading inspect for damage immediately.

CHECKING THE OIL LEVEL.

The jacks are normally supplied filled and ready for use. However before using the jack for the first time, the oil level should be checked. The oil used should be a high quality hydraulic oil of HVI ISO46 viscosity, e.g. Hi-force HFO32.

Remove the dipstick (See figure 1) and check the oil level. The maximum level is marked on the

dipstick. The level should be within 5mm of this mark. The dipstick should be screwed fully into position to determine this level.

OPERATION OF JACK. See Figure 1.

 Note: The permissible working load and stroke of the Jack are marked on the side.

The JAH series Jacks (1) have an in-built hydraulic pump which is worked by means of an operating lever (2), under the control of the operator. The piston (3) is raised on each downwards stroke of the lever. For lifting, the lever is placed fully into the operating quadrant (4). Three positions are provided to enable the user to choose the best ergonomic position. For lowering, the piston the lever is removed from the quadrant and placed into the release screw (5). Turning this anticlockwise will allow the piston to descend. The amount this is rotated will control the speed of decent. Only open a very small amount (approx. 5°) at first. Rotate clockwise, hand tight after use, to ready the jack for the next operation.

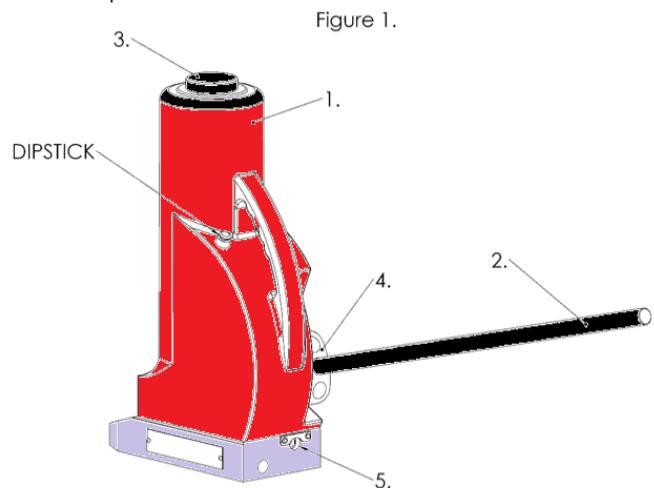

JACKS WITH LOCKING COLLARS (TYPE SR)

 All models can be supplied with threaded pistons and locking collars to mechanically support the load without relying on the hydraulic circuit. When the load is at the required position, rotate the locking collar clockwise until it rest hand-tight on the top of the jack body. To undo – operate the jack so that the hydraulic circuit just takes the load of the locking collar. Rotate the collar anticlockwise until it reaches the top of the piston.

Hi-Force®
HYDRAULIC TOOLS
INSTRUCTION MANUAL: Aluminium Jacks
Model Series: JAS, JAH

JACKS WITH LIFTING CLAWS (TYPE C)

 Claws are supplied as an accessory to provide a low height lifting point. When fitted, lifting must always and only be carried out on the toe of the claw. **See Figure 2.**

Figure 2.



The capacity of the claw is 40% of the capacity of the jack to which it is fitted. Lifting claws must NOT be fitted to threaded piston jacks. Lifting claws must only be used with jacks having extended bases that extend under the toe of the claw. They must ONLY be used for vertical movements of loads.

The recess on the underside of the top of the claw fits around the top of the piston. The heel of the claw rests against the front face of the jack. Ensure that the claw is seated properly before use and that the toe is as far under the load as possible.

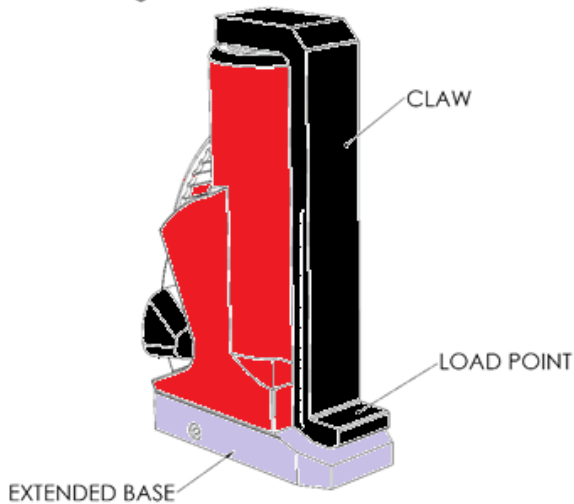
 **OPERATING POSITIONS**

The Jack should be used in the two positions shown below, **See Figure 3.**



Figure 3

 **STROKE LIMITER**

PISTON STROKE LIMITING DEVICE:

For Operator safety, all JAH jacks are factory-fitted with a fail-safe positive stop mechanism that prevents the over-stroking of the piston under loaded conditions beyond its maximum stated travel length. If the jack is operated in the over-stroke mode, oil is by-passed back to the reservoir to prevent the piston travelling further than its designed stroke distance.

If pumping of the jack with the operating lever is continued with the piston in the over-stroke operation mode, some oil may by-pass the stop mechanism and appear at the top of the jack. If this occurs, cease operating the jack and wipe off any surplus oil.

 **PLEASE NOTE:** That if the over-stroke mechanism is operated and continuously pumped with the piston under no load conditions, insufficient pressure is achieved in the system to engage the by-pass system of oil to the reservoir, and within a short number of pumping actions, oil will appear at the top of the jack.

 **OPERATING ENVIRONMENT**

The jack is intended for use in industrial environments, in or outdoors between temperatures of -20 to +50°C. Outside these parameters, consult Hi-Force Ltd, before use.